



## Combination Light Pattern

Some IONNIC LED Worklamps combined both spot and flood light patterns in one unit.

This allowed users to switch between spot light for a refined long range beam, and flood light for illuminating large areas.

They can also be turn on at the same time as combination beam to have the best of both worlds.



## Heavy Duty Mounts

The 200 & 400 series IONNIC LED worklamps are supplied with vibration dampening mounts as standard.

These heavy duty mounting systems absorb vibration & shocks preventing damage to the worklamp and prolonging bulb life.

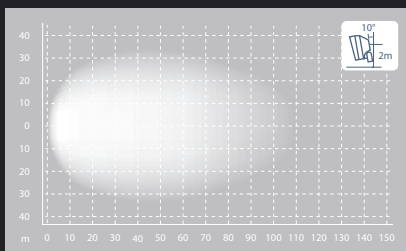
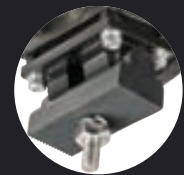
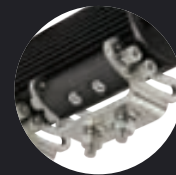
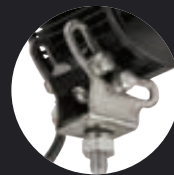

Flood Light Pattern

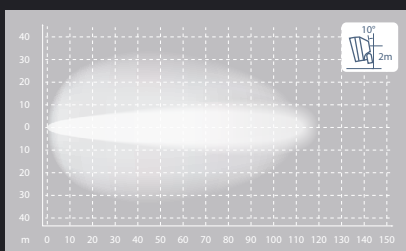

Combination Light Pattern



## IONNIC LED

204 LED 70

212 LED 71

220 LED 72

230 LED 73

406 LED 74

412 LED 75

417 LED 76

1090 LED 77

508 LED 78

2100 LED 79

BL LED 80

Remote Controlled LED 82

LED Scene Light 84

107 LED 86

# IONNIC LED

204 LED



- Stainless steel mounting bracket.
- Long life LEDs.
- Stainless steel cable gland.
- Even light pattern without hotspots.
- Impact resistant lens.
- Environmentally sealed aluminium body.
- Multi-voltage.
- 2 year warranty.

<b>Lumen Output :</b>	1,170lm
<b>Operational Voltage :</b>	10-30V
<b>Input Current :</b>	0.9A @ 13.8V
<b>LED Lifetime :</b>	50,000 Hrs
<b>Connector :</b>	Deutsch 2 Pin on 200mm Fly Lead
<b>Mount :</b>	Single Bolt M10
<b>Lens :</b>	Polycarbonate
<b>Body :</b>	Aluminium
<b>Bracket :</b>	Stainless Steel
<b>Weight :</b>	0.6kg
<b>Ingress Protection :</b>	IP67
<b>Operating Temperature :</b>	-40°C to 85°C
<b>Colour Temperature :</b>	6500K
<b>Light Source :</b>	6 x Cree® 3 Watt LEDs

10V  
30V

IP67

5Yrs



Stainless steel cable gland

Heavy duty stainless steel bracket

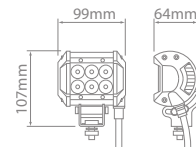

## 204 LED – Flood

Part No. **98-204F** Operational Voltage **10-30**

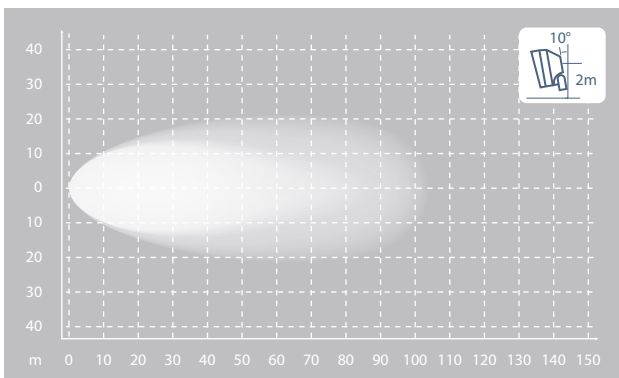

## 204 LED – Spot

Part No. **98-204S** Operational Voltage **10-30**

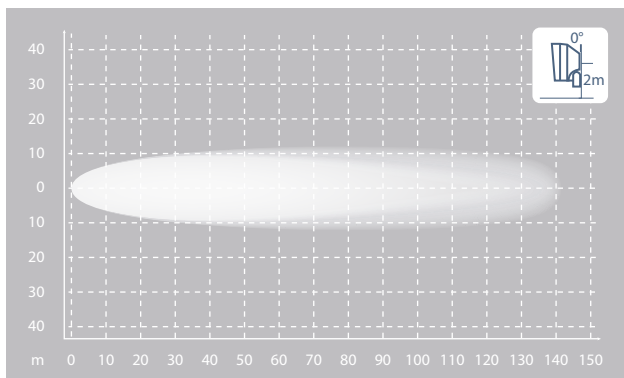

- Heavy duty stainless steel mounting bracket.
- Long life LEDs.
- Stainless steel cable gland.
- Even light pattern without hotspots.
- Impact resistant lens.
- Environmentally sealed aluminium body.
- Multi-voltage.
- 2 year warranty.



**Lumen Output :** 4,680lm  
**Operational Voltage :** 10-30V  
**Input Current :** 4.1A @ 13.8V  
**LED Lifetime :** 50,000 Hrs  
**Connector :** Deutsch 2 Pin on 200mm Fly Lead  
**Mount :** 2 x M10  
**Lens :** Polycarbonate  
**Body :** Aluminium  
**Bracket :** Stainless Steel  
**Weight :** 2.3kg  
**Ingress Protection :** IP67  
**Operating Temperature :** -40°C to 85°C  
**Colour Temperature :** 6500K  
**Light Source :** 24 x Cree® 3 Watt LEDs

10V 30V
IP67
5Yrs

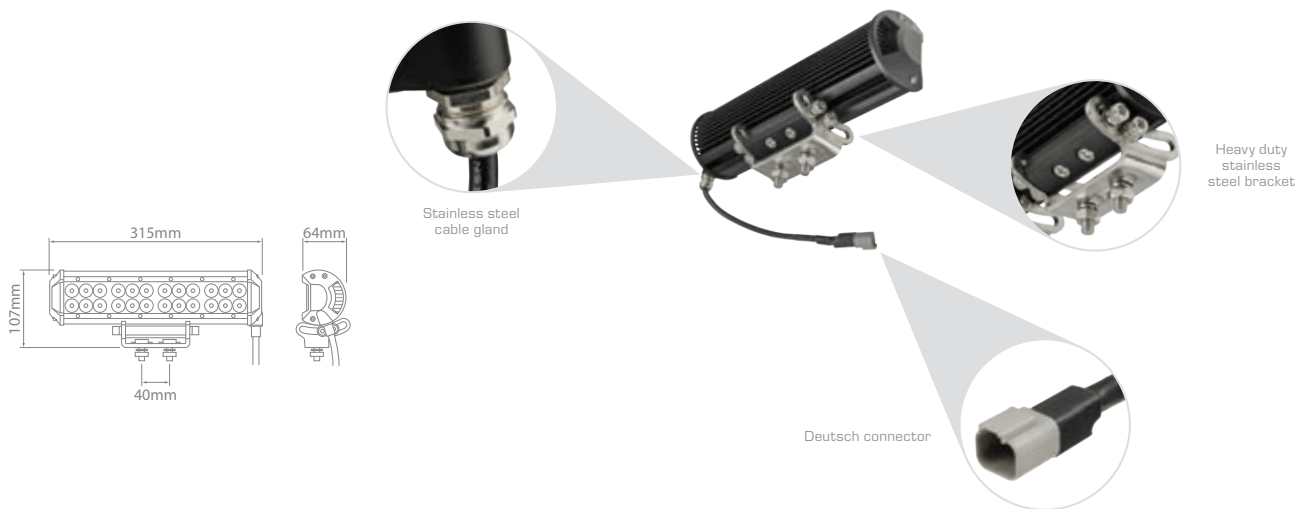

## 212 LED – Spot

**Part No.** 98-212S      **Operational Voltage** 10-30

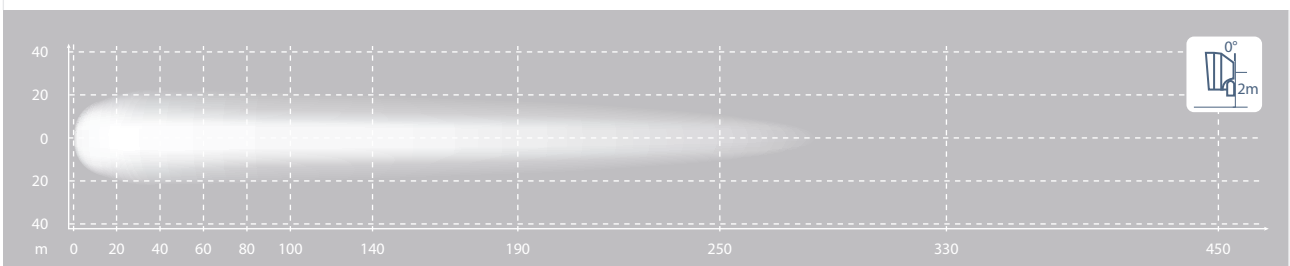

# IONNIC LED

220 LED



- Heavy duty stainless steel mounting bracket.
- Long life LEDs.
- Stainless steel cable gland.
- Even light pattern without hotspots.
- Impact resistant lens.
- Environmentally sealed aluminium body.
- Multi-voltage.
- 2 year warranty.

<b>Lumen Output :</b>	8,190lm
<b>Operational Voltage :</b>	10-30V
<b>Input Current :</b>	7.3A @ 13.8V
<b>LED Lifetime :</b>	50,000 Hrs
<b>Connector :</b>	Deutsch 2 Pin on 200mm Fly Lead
<b>Mount :</b>	4 x M10
<b>Lens :</b>	Polycarbonate
<b>Body :</b>	Aluminium
<b>Bracket :</b>	Stainless Steel
<b>Weight :</b>	3.1kg
<b>Ingress Protection :</b>	IP67
<b>Operating Temperature :</b>	-40°C to 85°C
<b>Colour Temperature :</b>	6500K
<b>Light Source :</b>	42 x Cree® 3 Watt LEDs

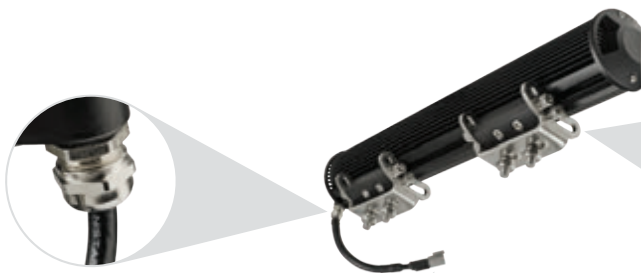

Stainless steel cable gland

Heavy duty stainless steel bracket



Deutsch connector

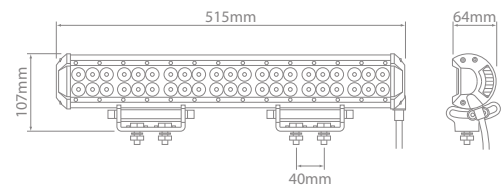

## 220 LED – Spot

Part No. **98-220S** Operational Voltage **10-30**

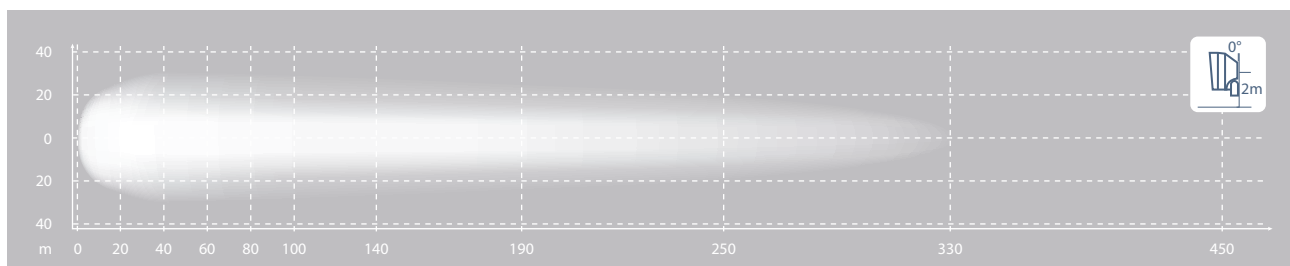

- Heavy duty stainless steel mounting bracket.
- Long life LEDs.
- Stainless steel cable gland.
- Even light pattern without hotspots.
- Impact resistant lens.
- Environmentally sealed aluminium body.
- Multi-voltage.
- 2 year warranty.



**Lumen Output :** 12,870lm  
**Operational Voltage :** 10-30V  
**Input Current :** 11.8A @ 13.8V  
**LED Lifetime :** 50,000 Hrs  
**Connector :** Deutsch 2 Pin on 200mm Fly Lead  
**Mount :** 6 x M10  
**Lens :** Polycarbonate  
**Body :** Aluminium  
**Bracket :** Stainless Steel  
**Weight :** 4.9kg  
**Ingress Protection :** IP67  
**Operating Temperature :** -40°C to 85°C  
**Colour Temperature :** 6500K  
**Light Source :** 66 x Cree® 3 Watt LEDs

10V 30V IP67 5Yrs

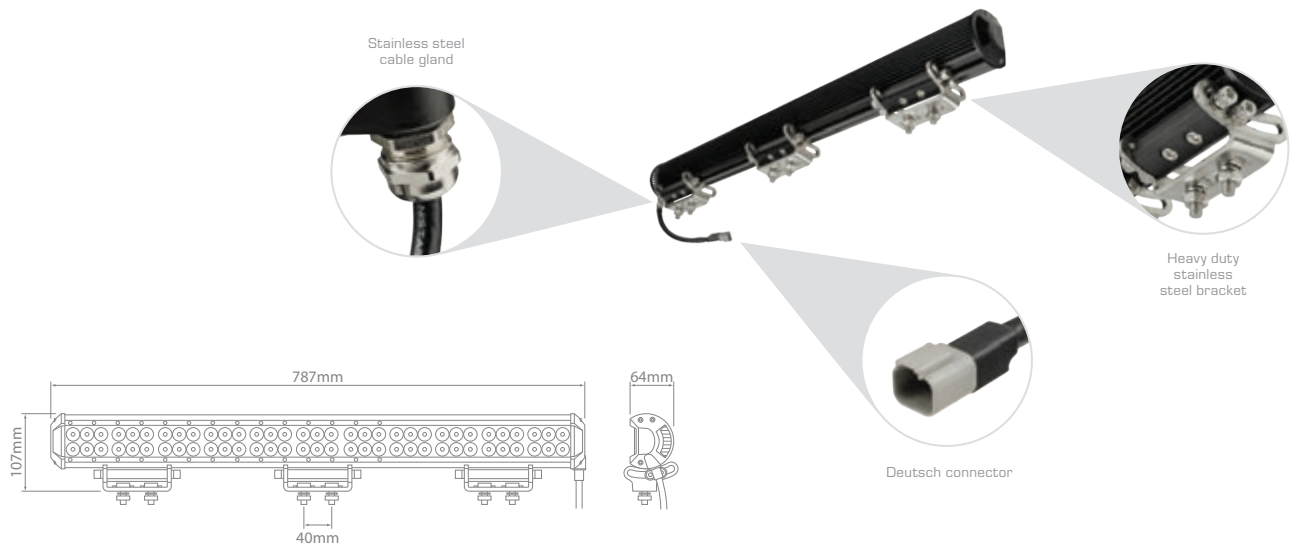

## 230 LED – Spot

**Part No.** 98-230S  
**Operational Voltage** 10-30

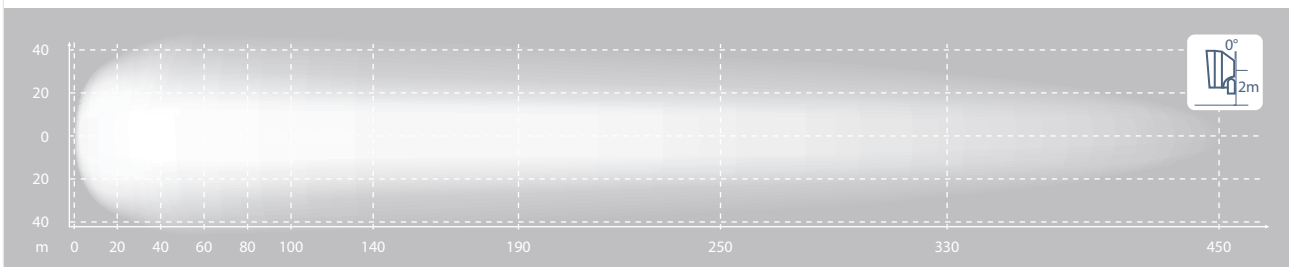

# IONNIC LED

406 LED



10V  
30V IP67 5Yrs

- Heavy duty stainless steel mounting bracket.
- Long life LEDs.
- Stainless steel cable gland.
- Even light pattern without hotspots.
- Combination model offers independent control of LED rows.
- Impact resistant lens.
- Environmentally sealed aluminium body.
- Multi-voltage.
- 2 year warranty.

<b>Lumen Output :</b>	4,680lm
<b>Operational Voltage :</b>	10-30V
<b>Input Current :</b>	4.0 @ 13.8V
<b>LED Lifetime :</b>	50,000 Hrs
<b>Connector :</b>	Flood Deutsch 2 Pin on Fly Lead
	Combination Deutsch 3 Pin on Fly Lead
<b>Mount :</b>	2 x M10
<b>Lens :</b>	Polycarbonate
<b>Body :</b>	Aluminium
<b>Bracket :</b>	Stainless Steel
<b>Weight :</b>	2.2kg
<b>Ingress Protection :</b>	IP67
<b>Operating Temperature :</b>	-40°C to 85°C
<b>Colour Temperature :</b>	6500K
<b>Light Source :</b>	24 x Cree® 3 Watt LEDs

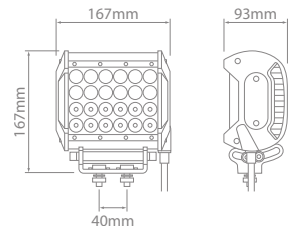
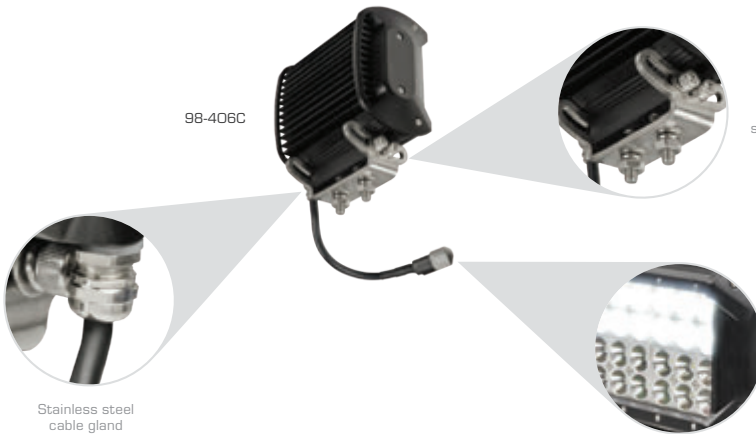

## 406 LED – Combination

Part No. **98-406C** Operational Voltage **10-30** Pattern depicts spot & flood combined illumination

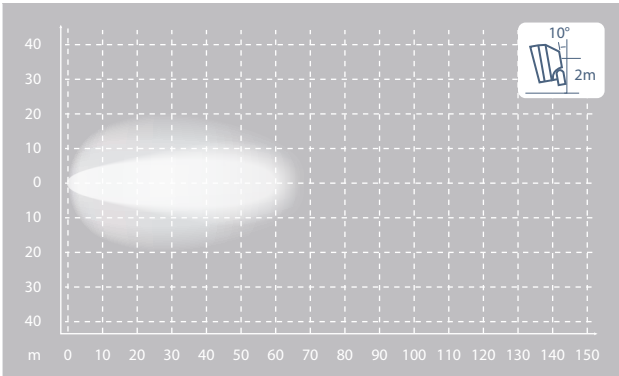

## 406 LED – Flood

Part No. **98-406F** Operational Voltage **10-30**

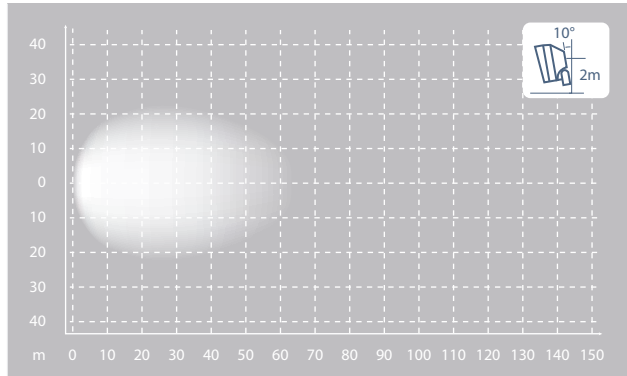

- Heavy duty stainless steel mounting bracket.
- Long life LEDs.
- Stainless steel cable gland.
- Even light pattern without hotspots.
- Combination model offers independent control of LED rows.
- Impact resistant lens.
- Environmentally sealed aluminium body.
- Multi-voltage.
- 2 year warranty.



**Lumen Output :** 9,360lm  
**Operational Voltage :** 10-30V  
**Input Current :** 8.2A @ 13.8V  
**LED Lifetime :** 50,000 Hrs  
**Connector :** Flood Deutsch 2 Pin on Fly Lead  
                   Combination Deutsch 3 Pin on Fly Lead  
**Mount :** 2 x M10  
**Lens :** Polycarbonate  
**Body :** Aluminium  
**Bracket :** Stainless Steel  
**Weight :** 4.0kg  
**Ingress Protection :** IP67  
**Operating Temperature :** -40°C to 85°C  
**Colour Temperature :** 6500K  
**Light Source :** 48 x Cree® 3 Watt LEDs

10V 30V IP67 5Yrs

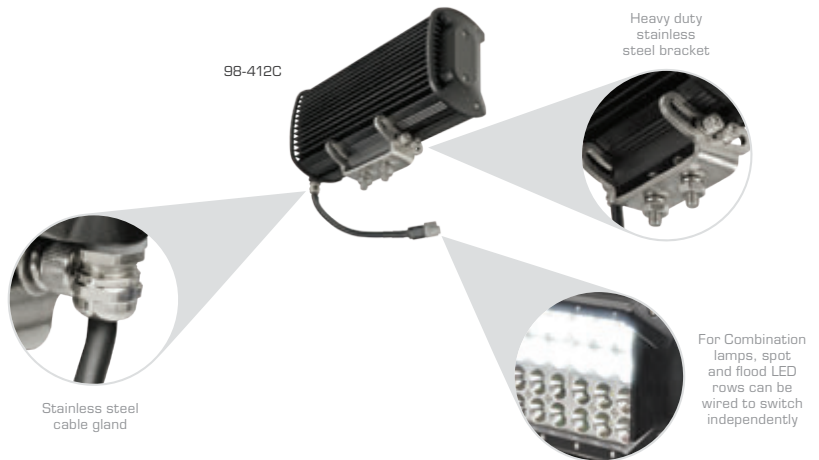
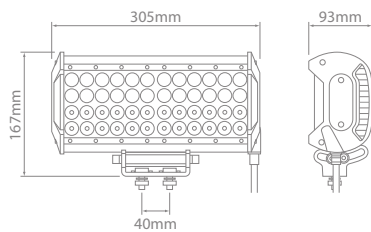

## 412 LED – Combination

**Part No.** 98-412C      **Operational Voltage** 10-30V      **Pattern depicts spot & flood combined illumination**

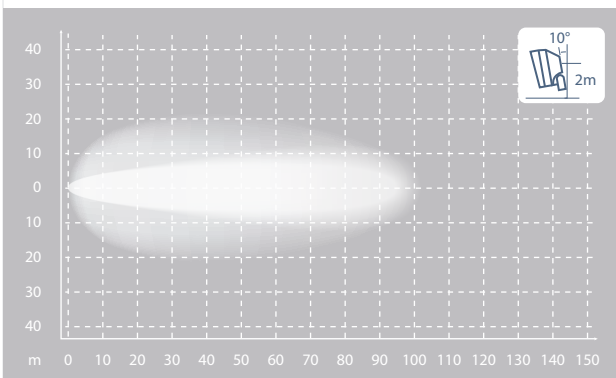

## 412 LED – Flood

**Part No.** 98-412F      **Operational Voltage** 10-30V

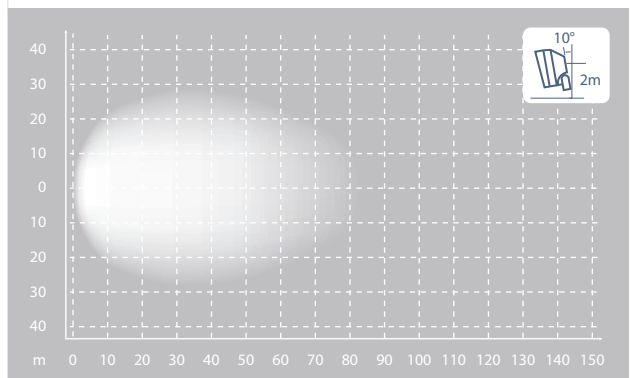



# IONNIC LED

417 LED



- Heavy duty stainless steel mounting bracket.
- Long life LEDs.
- Stainless steel cable gland.
- Even light pattern without hotspots.
- Combination model offers independent control of LED rows.
- Impact resistant lens.
- Environmentally sealed aluminium body.
- Multi-voltage.
- 2 year warranty.

10V  
30V IP67 5Yrs

<b>Lumen Output :</b>	14,040lm
<b>Operational Voltage :</b>	10-30V
<b>Input Current :</b>	12.5A @ 13.8V
<b>LED Lifetime :</b>	50,000 Hrs
<b>Connector :</b>	Flood Deutsch 2 Pin on Fly Lead
	Combination Deutsch 3 Pin on Fly Lead
<b>Mount :</b>	4 x M10
<b>Lens :</b>	Polycarbonate
<b>Body :</b>	Aluminium
<b>Bracket :</b>	Stainless Steel
<b>Weight :</b>	5.2kg
<b>Ingress Protection :</b>	IP67
<b>Operating Temperature :</b>	-40°C to 85°C
<b>Colour Temperature :</b>	6500K
<b>Light Source :</b>	72 x Cree® 3 Watt LEDs



Stainless steel cable gland

98-417C



Heavy duty stainless steel bracket

For Combination lamps, spot and flood LED rows can be wired to switch independently

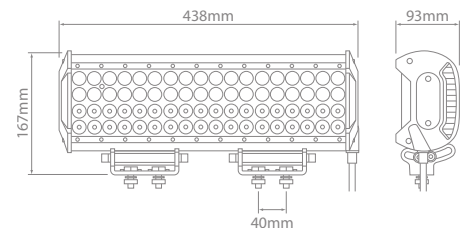

## 417 LED – Combination

Part No. **98-417C** Operational Voltage **10-30** Pattern depicts spot & flood combined illumination

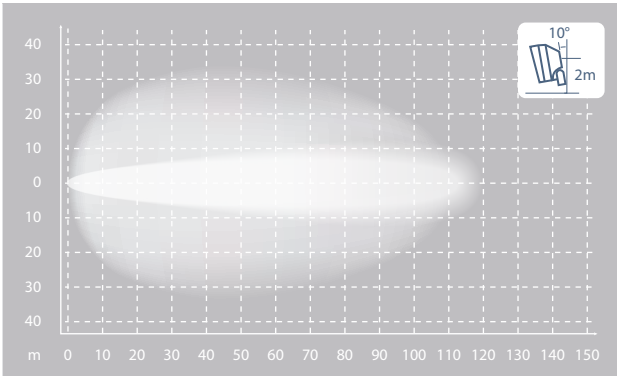

## 417 LED – Flood

Part No. **98-417F** Operational Voltage **10-30**

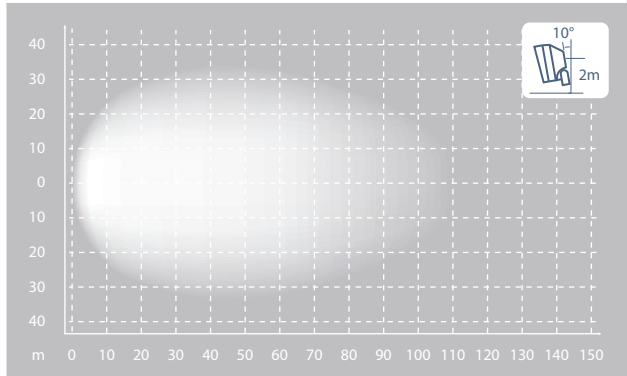

- Multi-voltage.
- Long life LEDs.
- Low current draw.
- Extremely compact & lightweight.
- Even light pattern without hotspots.
- Impact resistant lens.
- Epoxy encapsulated electronics.
- Environmentally sealed aluminum body.
- 5 year warranty.



**Lumen Output :** 600lm  
**Operational Voltage :** 12-36V  
**Input Current :** 0.68A @ 13.5V  
**Max Power Consumption :** 9W  
**LED Lifetime :** 50,000 Hrs  
**Connector :** 280mm Fly Lead  
**Mount :** Single Bolt M8  
**Lens :** PC  
**Body :** Aluminium  
**Bracket :** Stainless Steel  
**Weight :** 0.17kg  
**Ingress Protection :** IP67  
**Operating Temperature :** -30°C to 50°C  
**Colour Temperature :** 5000K  
**Light Source :** 3 x Edison® 3 Watt LEDs

12V  
36V
IP67
5Yrs

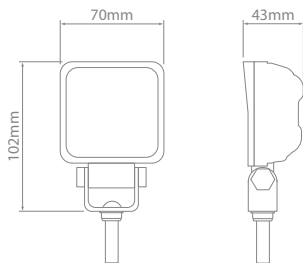

## 1090 LED – Flood

Part No.	Operational Voltage
98-1090	12-36
98-1090BK *	12-36

\* Bulk pack of 10 worklamps.

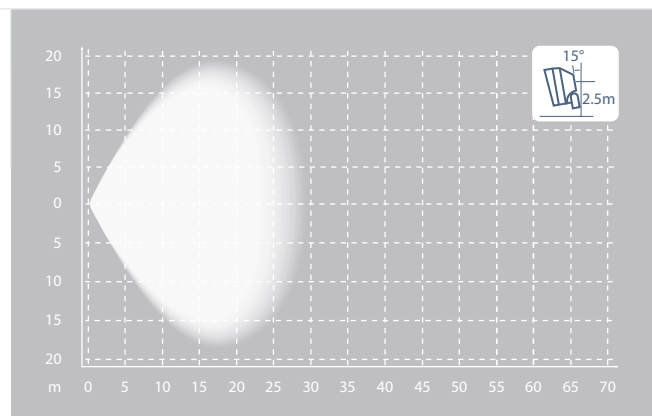

# IONNIC LED

508 LED



9V  
32V

IP67

5Yrs

- Compact & lightweight.
- Multi-voltage.
- Long life LEDs.
- Low current draw.
- Even light pattern without hotspots.
- Impact resistant lens.
- Environmentally sealed aluminum body.
- 5 year warranty.

**Lumen Output :** 1,260lm  
**Operational Voltage :** 9-32V  
**Input Current :** 1.0A @ 13.8V  
**LED Lifetime :** 30,000 Hrs  
**Connector :** Deutsch 2 Pin on 200mm Fly Lead  
**Mount :** Single Bolt M10  
**Lens :** PC  
**Body :** Aluminium  
**Bracket :** Stainless Steel  
**Weight :** 0.6kg  
**Ingress Protection :** IP67  
**Operating Temperature :** -45°C to 65°C  
**Colour Temperature :** 6500K  
**Light Source :** 6 x Cree® 3 Watt LEDs

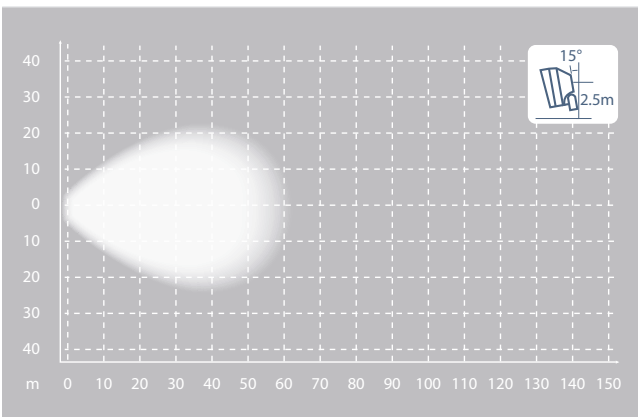
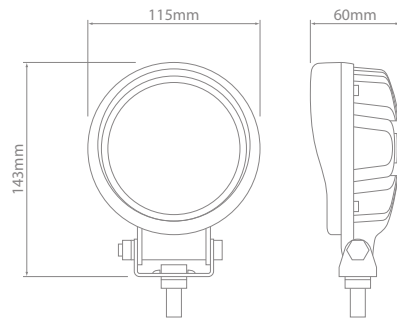

## 508 LED – Flood

Part No. **98-508F** Operational Voltage **9-32**

- Handle & spring tensioned bracket for easy on-site adjustment.
- Integrated rocker switch with sealing boot.
- Multi-voltage.
- Long life LEDs.
- Low current draw.
- Even light pattern without hotspots.
- Impact resistant lens.
- Environmentally sealed aluminum body.
- 3 year warranty.



**Lumen Output :** 1,490lm  
**Operational Voltage :** 12-36V  
**Input Current :** 1.4A @ 13V  
**Max Power Consumption :** 22W  
**LED Lifetime :** 30,000 Hrs  
**Connector :** Deutsch 2 Pin on 280mm Fly Lead  
**Mount :** user supplied 4 x M8  
**Lens :** PC  
**Body :** Aluminium  
**Bracket :** Stainless Steel  
**Weight :** 0.6kg  
**Ingress Protection :** IP67  
**Operating Temperature :** -30°C to 50°C  
**Colour Temperature :** 6500K  
**Light Source :** 9 x SMD High Power LEDs

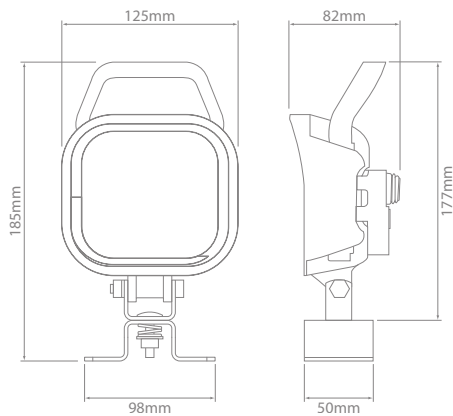

Rocker switch with sealing boot



Spring tensioned bracket for easy on-site adjustment



## 2100 LED – Flood

**Part No.** 98-2100  
**Operational Voltage** 12-36

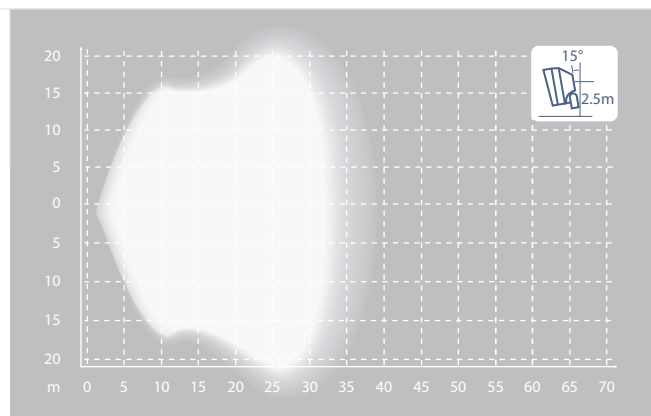

# IONNIC LED

BL LED

**NEW**



- 12V / 48V
- IP68
- IP 6K9K
- 5Yrs

- Protective shroud reduces lateral light dispersion
- Optional remote handles for easy in-cab adjustment.
- Multi-voltage.
- Long life LEDs.
- Even light pattern without hotspots.
- Impact resistant lens.
- Environmentally sealed aluminium body.
- 5 year warranty.

<b>Lumen Output :</b>	2,650lm
<b>Operational Voltage :</b>	12-48V
<b>Input Current :</b>	4.5A @ 13.8V
<b>LED Lifetime :</b>	30,000 Hrs
<b>Connector :</b>	Deutsch 2 Pin on 200mm Fly Lead
<b>Lens :</b>	PMMA
<b>Body :</b>	Die-cast
<b>Ingress Protection :</b>	IP68, IP6K9K
<b>Approvals :</b>	SAE J1455
<b>Operating Temperature :</b>	-40°C to 85°C
<b>Colour Temperature :</b>	6500K
<b>Light Source :</b>	12 x Cree® 5 Watt LEDs



BLLED + BL420



Remote control handle has 14 lockable positions for easy angle adjustment and retraction

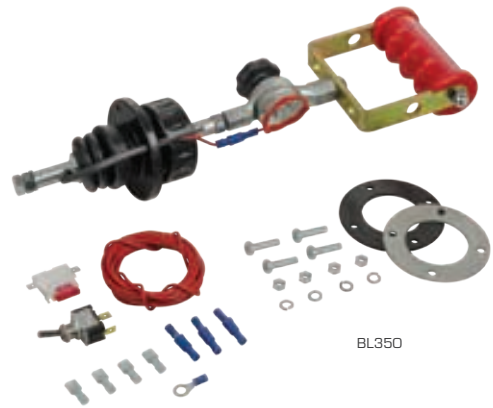

BL350

## Precision Illumination

When pairing with the remote control handle kit, the IONNIC BL LED worklamp can be controlled from inside the cabin to conveniently direct the light where required.

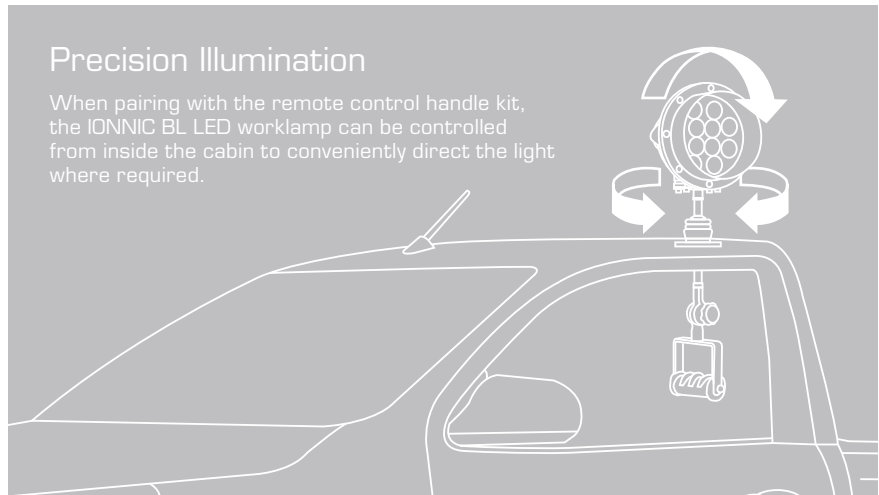

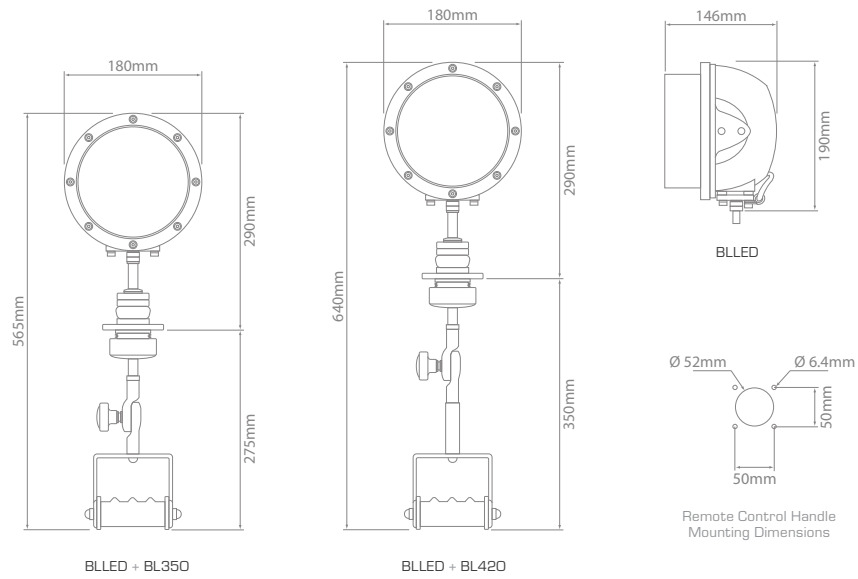

## BL LED – Spot

Part No.	Operational Voltage	Description
<b>BLLED</b>	12-48	BL LED Worklamp assembly
<b>BL350</b>	—	350mm Remote Control Handle Kit with toggle switch, fuse and mounting plate
<b>BL420</b>	—	420mm Remote Control Handle Kit with toggle switch, fuse and mounting plate

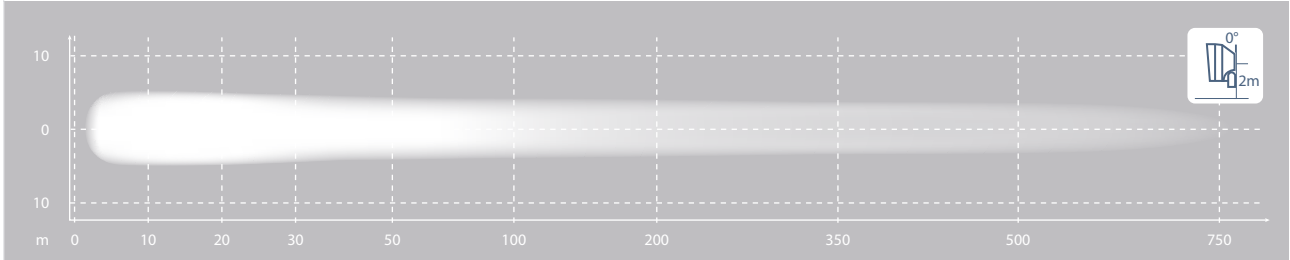

## BL LED – Spare Parts

Part No.	Description
<b>BLB-BOOT</b>	Replacement boot, suits both Remote Control Handles



# IONNIC LED

## Remote Controlled LED



IP65 3Yrs

- Can be remote controlled within 200m.
- Adjustable to 360° horizontal & 120° vertical.
- Worklamp can be detached from mounted base. Convenient magnetic mount suitable for stationary applications only.
- Folding handle.
- Impact resistant lens.
- Long life LEDs.
- Environmentally sealed body.
- 3 year warranty.

<b>Lumen Output :</b>	4,000lm
<b>Max Power Consumption :</b>	50W
<b>Connector :</b>	2.8m lead to cigar plug
<b>Body :</b>	ABS
<b>Lens :</b>	Polycarbonate
<b>Weight :</b>	3kg
<b>Ingress Protection :</b>	IP65
<b>Operating Temperature :</b>	-40°C to 85°C
<b>Colour Temperature :</b>	6500K
<b>Light Source :</b>	10 x Cree® 5 Watt LEDs

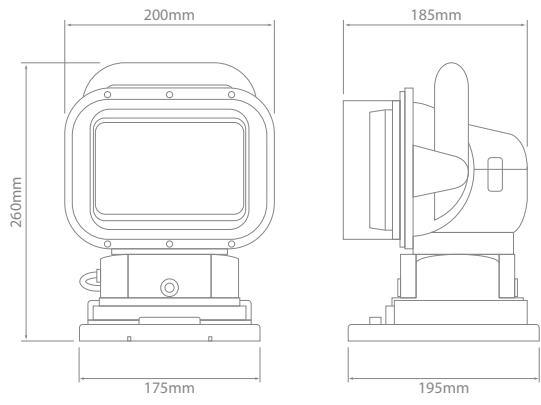

## Remote Controlled LED – Spot

Part No.	Voltage
<b>98-150-12V</b>	12
<b>98-150-24V</b>	24

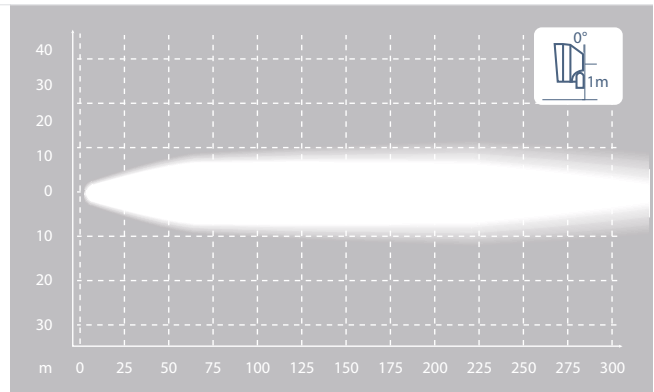



# IONNIC LED

LED Scene Light

**NEW**

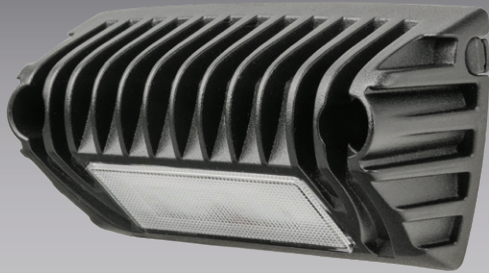

9V  
32V

IP67

ECE  
R10

- Ideal for interior or exterior applications.
- Compact & lightweight.
- Multi-voltage.
- Long life LEDs.
- Low current draw.
- Impact resistant lens.
- Environmentally sealed aluminum body.

<b>Lumen Output :</b>	500lm
<b>Operational Voltage :</b>	9-32V
<b>Input Current :</b>	0.8A @ 13.8V
<b>LED Lifetime :</b>	30,000 Hrs
<b>Connector :</b>	300mm Fly Lead
<b>Mount :</b>	2 x M6 bolts
<b>Lens :</b>	PC
<b>Body :</b>	Aluminium
<b>Weight :</b>	0.2kg
<b>Ingress Protection :</b>	IP67
<b>Approvals :</b>	ECE R10
<b>Operating Temperature :</b>	-30°C to 60°C
<b>Colour Temperature :</b>	6500K
<b>Light Source :</b>	6 X Cree® 1.5 Watt LEDs

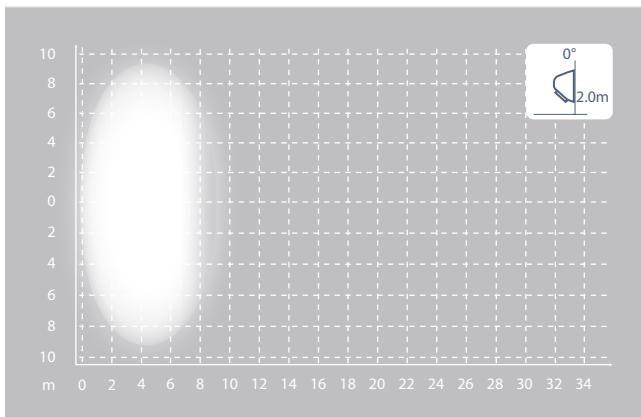
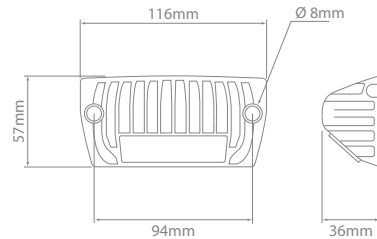

## LED Scene Light

Part No.	Operational Voltage
<b>98-2500</b>	<b>9-32</b>

Supplied with adhesive gasket, bolts, nuts and split washers.

# Internet Internet

ionnic.com



- Keep up to date with the latest product releases.
- Compare products.
- Download catalogues or technical information.



ionnic.com



**ionnic** |   
Lighting | Safety | Electrical

# IONNIC LED

**NEW**



107 LED

- 12V  
48V
- IP68
- IP  
6K9K
- 5Yrs

- Heavy duty die-cast mounting bracket.
- Long life LEDs.
- Stainless steel cable gland.
- Even light pattern without hotspots.
- Impact resistant lens.
- Environmentally sealed aluminium body.
- Multi-voltage.
- 5 year warranty.

<b>Lumen Output :</b>	2,650lm
<b>Operational Voltage :</b>	12-48V
<b>Input Current :</b>	4.5A @ 13.8V
<b>LED Lifetime :</b>	30,000 Hrs
<b>Connector :</b>	Deutsch 2 Pin on 200mm Fly Lead
<b>Mount :</b>	Single Bolt M8
<b>Lens :</b>	PMMA
<b>Body :</b>	Aluminium
<b>Weight :</b>	2.1kg
<b>Ingress Protection :</b>	IP68, IP6K9K
<b>Approvals :</b>	SAE J1455
<b>Operating Temperature :</b>	-40°C to 85°C
<b>Colour Temperature :</b>	6500K
<b>Light Source :</b>	12 x Cree® 5 Watt LEDs

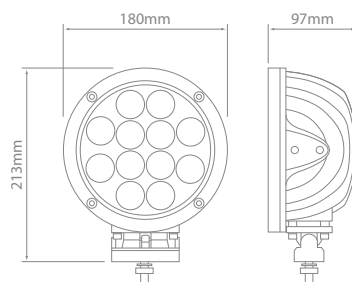

## 107 LED – Wide Spot

Part No.                      Operational Voltage  
**98-107F**                      **12-48**

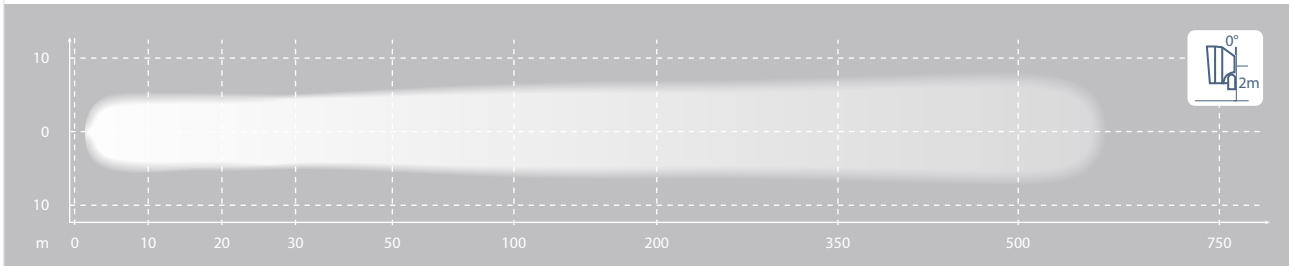

## 107 LED – Spot

Part No.                      Operational Voltage  
**98-107S**                      **12-48**

